



BODY HARDWARE COMPONENTS

SECTION 8



FREIGHTER CURTAIN RATCHETS

PRODUCT	PART NUMBER	DESCRIPTION
	FRT-190-20008	LEFT HAND RATCHET – SQUARE FRONT WALL AND RIGID BODY
	FRT-190-20009	RIGHT HAND RATCHET – SQUARE FRONT WALL AND RIGID BODY
	FRT-190-20083	LEFT HAND RATCHET – FACET FRONT WALL
	FRT-190-20084	RIGHT HAND RATCHET – FACET FRONT WALL
	FRT-190-20057	LEFT HAND RATCHET – SUIT REAR WALL
	FRT-190-20058	RIGHT HAND RATCHET – SUIT REAR WALL
	FRT-237-00479	HANDLE – SUIT RATCHET FOR SQUARE FRONT WALL
	FRT-237-00480	HANDLE – SUIT RATCHET FOR FACET FRONT WALL



FREIGHTER CURTAIN TENSIONER OLD STYLE

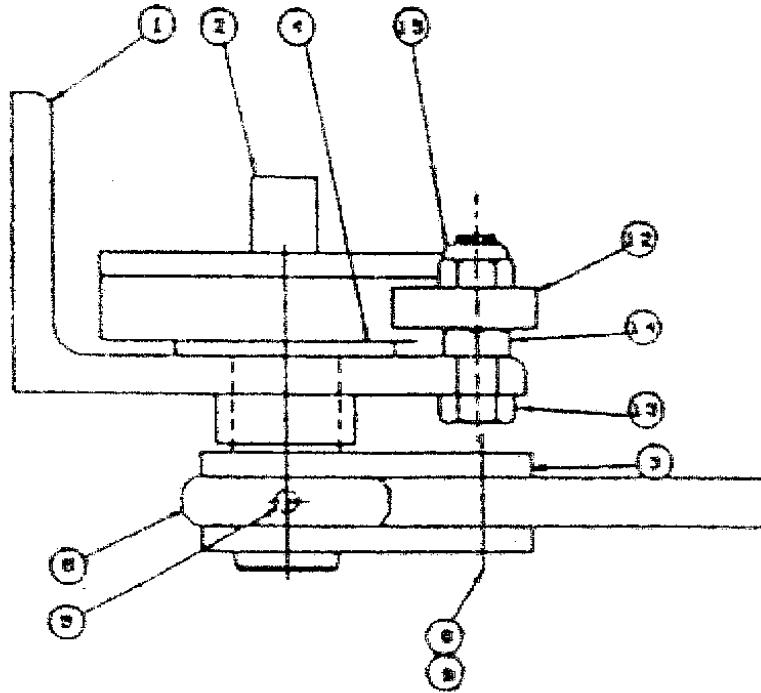

ITEM	PART NUMBER	DESCRIPTION
1	FRT-190-20025	ANGLE BRACKET ASSEMBLY
2	FRT-190-20024	RATCHET WHEEL AND SHAFT ASSEMBLY
3	FRT-190-20031	BRACKET - HANDLE PIVOT
4	FRT-161-66512	WASHER - M27
5	HDW-RP-0250-12	ROLL PIN - 1/4" x 1 1/2"
6	FRT-190-20019	GEAR - RATCHET HANDLE
7	FRT-237-00479	CAST HANDLE - STRAIGHT
7a	FRT-237-00480	CAST HANDLE - BEVEL
8	FRT-152-10081	SHOULDER SCREW - 3/8" x 1"
9	FRT-151-15303	NUT - 5/16" NYLOC
10	FRT-190-20035	PIVOT PLATE
11	FRT-151-50021	BOLT - 5/16" X 3/4"
12	FRT-190-20016	RATCHET PAWL
13	HDW-B-0375-12	BOLT - 3/8" x 1 1/2" UNF
14	HDW-NF-0375	NUT - 3/8" UNF
15	HDW-NYLF-0375	NYLOC NUT - 3/8" LOW PROFILE
16	FRT-190-20015	SPRING - SUIT PAWL



CURTAIN RATCHETS

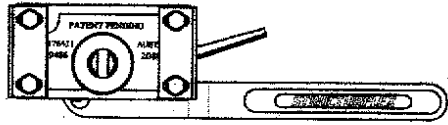

SXT-25-2501 - L.H ALUMINIUM RATCHET
STRUCTUREFLEX

SXT-25-2502 - R.H ALUMINIUM RATCHET
STRUCTUREFLEX

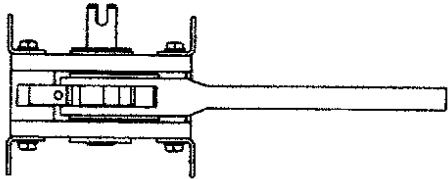

APPLICATION: VAWDREY
BARKER
VARIOUS RIGID BODIES



SXT-25-2598 - L.H RATCHET ASSEMBLY
COVERTEX

SXT-25-2599 - R.H RATCHET ASSEMBLY
COVERTEX

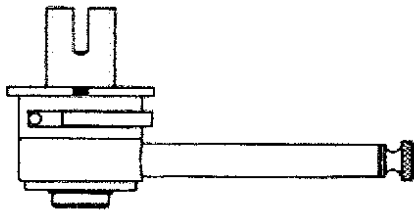

APPLICATION: VARIOUS RIGID BODIES

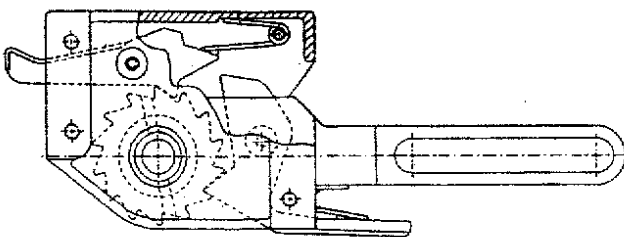

PFS-942526-1 - L.H ALUMINIUM RATCHET

PFS-942526-2 - R.H ALUMINIUM RATCHET

APPLICATION: KRUEGER KURTAINER
VARIOUS RIGID BODIES

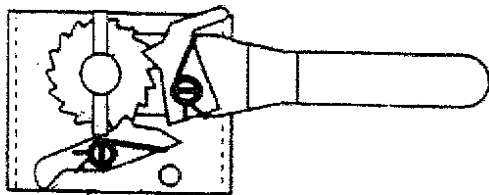

PFS-940138-1 - L.H CURTAIN RATCHET

PFS-940138-2 - R.H CURTAIN RATCHET

APPLICATION: EARLY KRUEGER KURTAINER
VARIOUS RIGID BODIES

MANY CURTAIN RATCHETS ARE USED ON RIGID BODY APPLICATIONS BY
LOCAL BODYBUILDERS



FREIGHTER CURTAIN TENSIONER NEW STYLE



MAX-102190 - LEFT HAND CURTAIN TENSIONER - MAXITRANS

MAX-102191 - RIGHT HAND CURTAIN TENSIONER - MAXITRANS

SPARE PARTS - TENSIONER

ITEM	PART NUMBER	DESCRIPTION	ITEM	PART NUMBER	DESCRIPTION
	MAX-1001	HOUSING ASSEMBLY – L.H		SXT-25-2508	SPRING – TRIGGER
	MAX-1002	HOUSING ASSEMBLY – R.H		MAX-1015	ROLL PIN – 6mm x 35mm
	MAX-1003	HANDLE ASSEMBLY		-	ROLL PIN – 4mm x 35mm
	MAX-1010	TRIGGER PAWL		-	ROLL PIN – 6mm x 35mm
	MAX-1009	LOCKING PAWL		MAX-1017	ROLL PIN – 6mm x 57mm
	MAX-1005	SHAFT		SXT-25-2506	BUSH – SUIT HANDLE
	SXT-25-2504	GEAR			
	SXT-25-2505	BODY BUSH			
	SXT-25-2507	WEAR WASHER			
	MAX-1011	LOADING WASHER			



STRUCTUREFLEX RATCHET SPARE PARTS

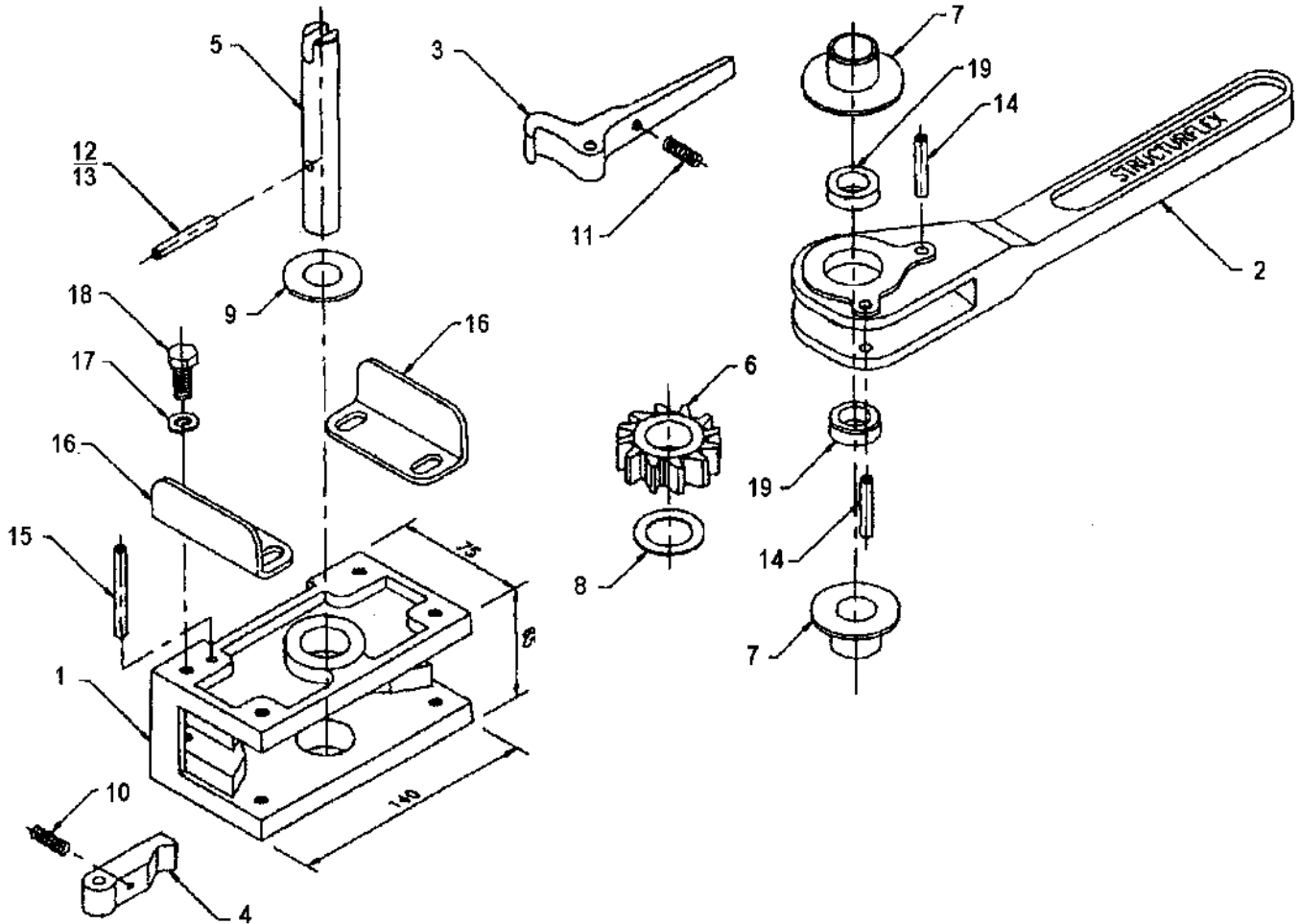

ITEM	PART NUMBER	DESCRIPTION	ITEM	PART NUMBER	DESCRIPTION
1	-	HOUSING ASSEMBLY	11	SXT-25-2509	SPRING – TRIGGER
2	SXT-25-2503	HANDLE – ALUMINIUM	12	-	ROLL PIN – 6mm x 35mm
3	-	TRIGGER PAWL	13	-	ROLL PIN – 4mm x 35mm
4	-	LOCKING PAWL	14	-	ROLL PIN – 6mm x 35mm
5	-	SHAFT	15	-	ROLL PIN – 6mm x 57mm
6	SXT-25-2504	GEAR	16	-	MOUNTING BRACKET
7	SXT-25-2505	BODY BUSH	17	HDW-WLS-0312	SPRING WASHER
8	SXT-25-2507	WEAR WASHER	18	HDW-BC0312-05	MOUNTING BOLT
9	-	LOADING WASHER	19	SXT-25-2506	BUSH – SUIT HANDLE
10	SXT-25-2508	SPRING - PAWL			

VARIOUS PARTS OFF THIS RATCHET ARE ALSO SUITABLE FOR THE NEW STYLE FREIGHTER RATCHET



CURTAIN ROLLERS

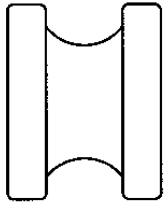

FRT-652-00188
FREIGHTER,MAXI CUBE
31mm O.D x 24mm WIDE
NYLON

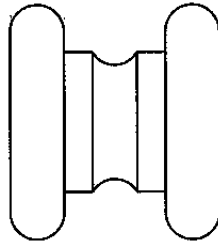

SXT-25-2587
KRUEGER
36mm O.D x 32mm WIDE
NYLON

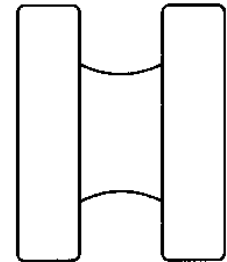

SXT-25-2588
BARKER / STRUCTUREFLEX
36mm O.D x 29mm WIDE
NYLON

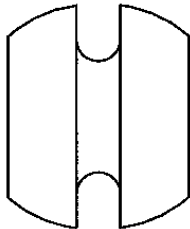

POLYWELD
36mm O.D x 29mm WIDE
NYLON

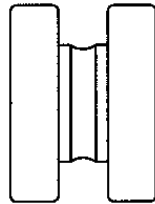

FRT-190-20082
FREIGHTER,MAXI CUBE
31mm O.D x 24mm WIDE
BEARING

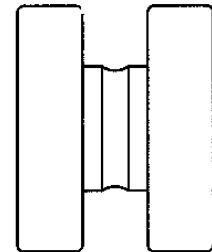

BARKER,STRUCTUREFLEX
36mm O.D x 29mm WIDE
BEARING

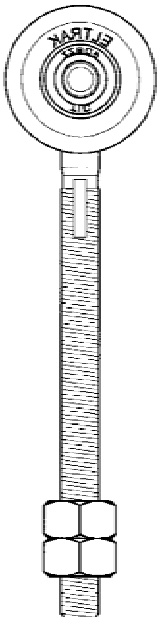

SXT-25-2593
STRUCTUREFLEX
36mm O.D x 30mm WIDE
BEARING

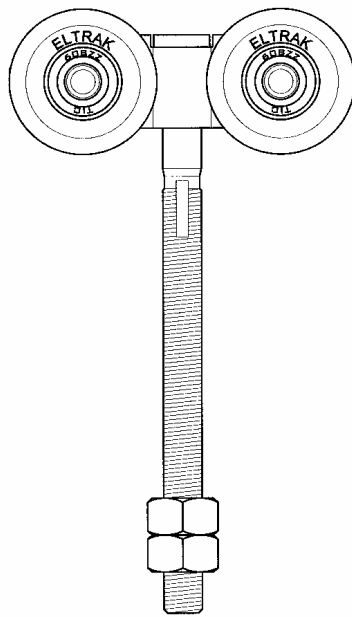

SXT-25-2585
STRUCTUREFLEX
36mm O.D x 30mm WIDE
BEARING

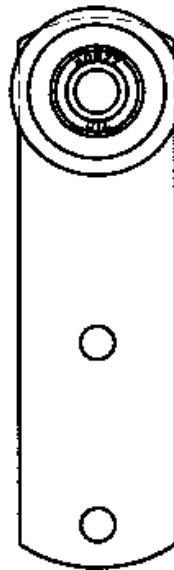

SXT-25-2594
FREIGHTER,MAXI CUBE
31mm O.D x 24mm WIDE
BEARING

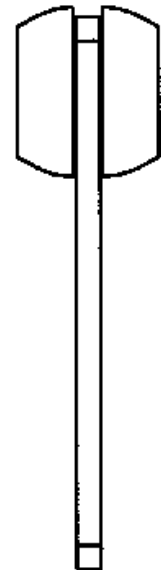

SXT-25-2595
COVERTEX
35mm O.D x 29mm WIDE
BEARING



CURTAIN ACCESSORIES

FRT-190-20003
50mm OPEN HOOK

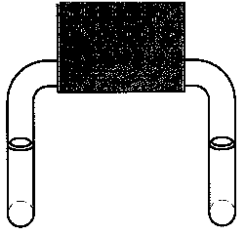

FRT-190-20010
ROPE RAIL HOOK

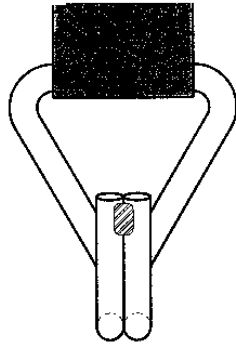

FRT-190-20012
RAVE HOOK

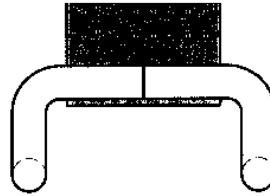

RAILINER HOOK

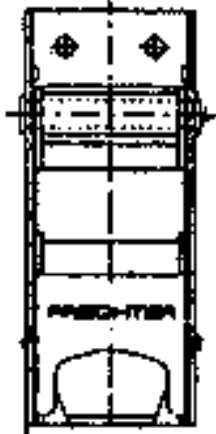
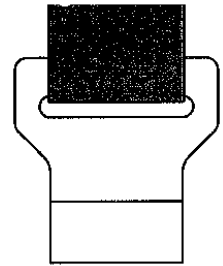

FRT-TL-007
CURTAIN BUCKLE
STAINLESS STEEL

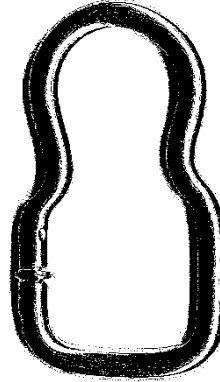

FRT-652-00190
WAISTED RING
FREIGHTER

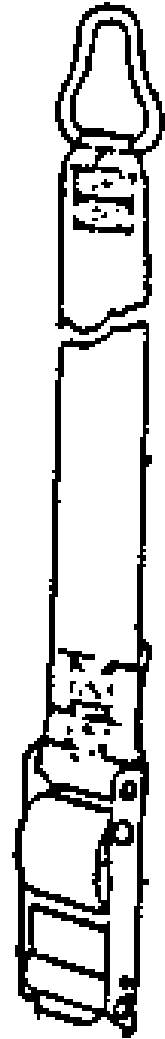

FRT-190-20060
STRAP, BUCKLE &
WAISTED RING
2440mm LONG

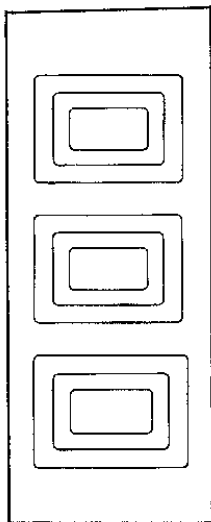

FRT-190-20047
TRIPLE EYELET
ALL CURTAIN COLOURS

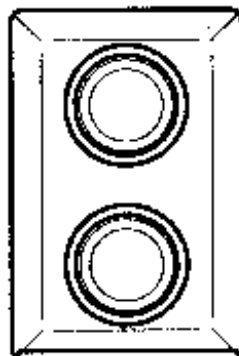

SXT-25-2596
PLASTIC CAP & INSERT
COVERTEX



CORNER AND WRAPPER POSTS

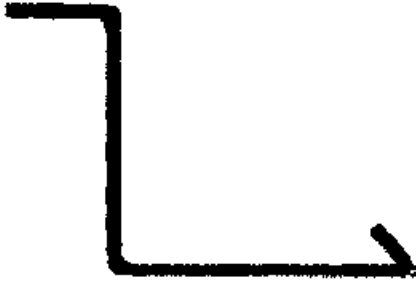

FRT-652-06304 - LEFT HAND POST – 5” FRONT WALL

FRT-652-06305 - RIGHT HAND POST – 5” FRONT WALL

MAINLY USED ON RIGID BODY APPLICATION

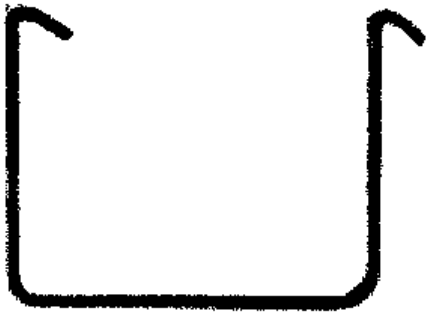

FRT-222-00515 - LEFT HAND POST – 6” FRONT WALL

FRT-222-00516 - RIGHT HAND POST – 6” FRONT WALL

RIGID BODY AND FREIGHTER SQUARE FRONT WALL

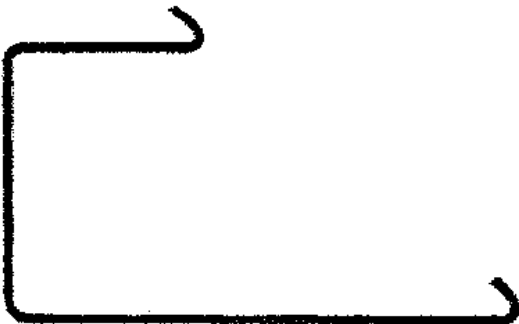

FRT-222-00572 - LEFT HAND POST – BEVELLED WALL

FRT-222-00573 - RIGHT HAND POST – BEVELLED WALL

FREIGHTER / MAXITRANS CURTAIN SIDER



FRT-652-00102 - WRAPPER POST – 2800mm LONG

FRT-652-53008 - WRAPPER POST – 3000mm LONG

FRT-652-00107 - TOP PIVOT PIN AND WASHER

SUITS MAXITRANS CURTAIN SIDERS AND RIGID BODIES



FREIGHTER ROOF COMPONENTS

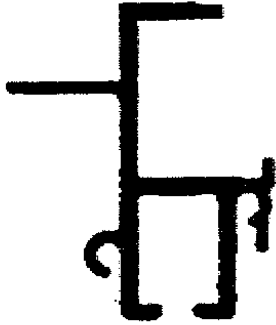

PART NUMBER: FRT-652-00129D - 7.5 METRE LENGTH
FRT-652-00129A - 9 METRE LENGTH
FRT-652-00129G - 13.6 METRE LENGTH
DESCRIPTION: ALUMINIUM CURTAIN TRACK - EARLY
100mm HIGH

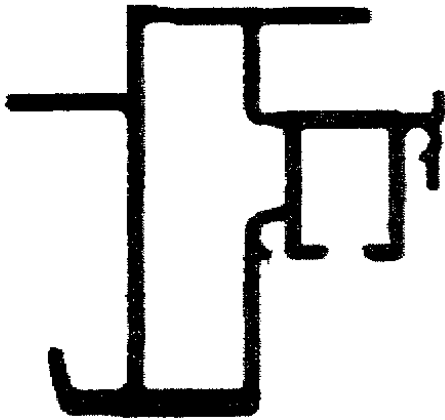

PART NUMBER: FRT-225-00323 - 7 METRE LENGTH
FRT-225-00324 - 9 METRE LENGTH
FRT-225-00274 - 13.7 METRE LENGTH
DESCRIPTION: ALUMINIUM CURTAIN TRACK - NEW
STRUCTURAL WITH SLIDE POST
TRACK INCLUDED

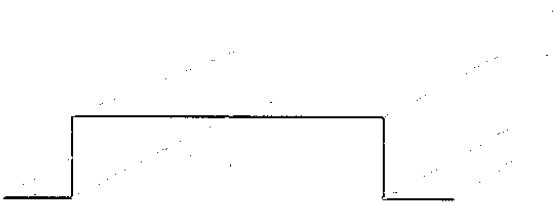

PART NUMBER: FRT-652-01408
DESCRIPTION: ALUMINIUM ROOF BOW
2406mm LONG

ROOF SHEET AND TAPE

FRT-106-00203F - ALUMINIUM ROOF SHEETING - 0.81mm x 1 LINEAL METRE
(2.515MM WIDE) CUT TO YOUR REQUIRED LENGTH
SOLD PER METRE

FRT-140-07513 - DOUBLE SIDED TAPE - 12mm WIDE
AVAILABLE IN A 33 METRE ROLL



8-9

VARIOUS CURTAIN TRACKS

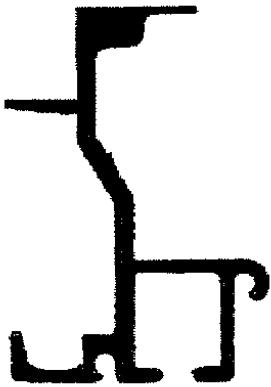

MAXI CUBE

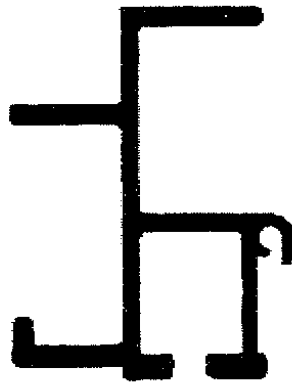

STRUCTUREFLEX

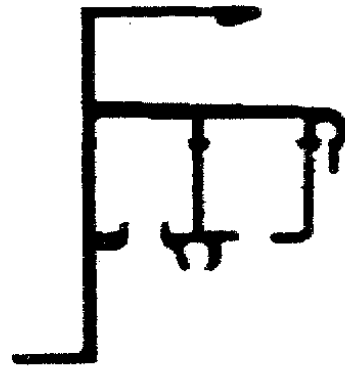

BARKER

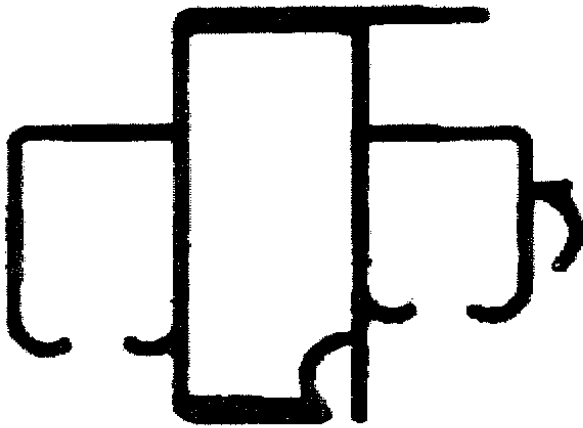

KRUEGER - STRUCTURAL

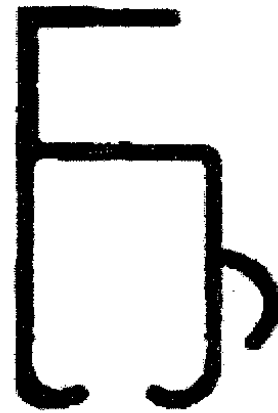

KRUEGER - SINGLE

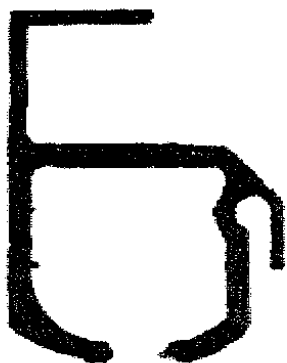

COVERTEX

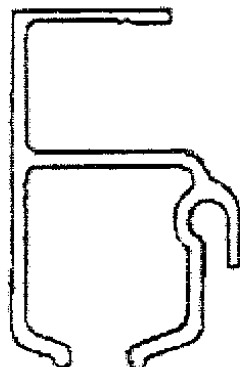

POLYWELD

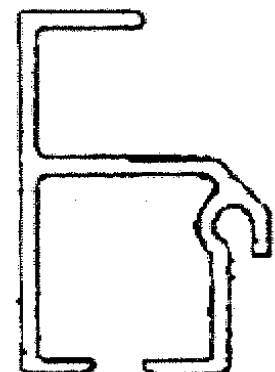

MCKECHNIE (NSW)



8-10

VARIOUS PELMET RUBBERS



FRT-652-00138B - PELMET RUBBER - WHITE

FRT-652-00138C - PELMET RUBBER - BLACK

APPLICATION: FREIGHTER / MAXITRANS

BOTH COLOURS SOLD PER METRE



MAXI CUBE



KRUEGER

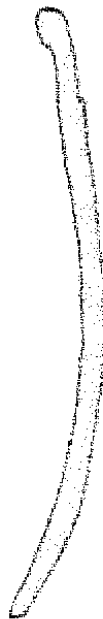

BARKER

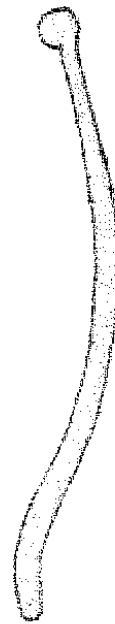

VAWDREY



POLYWELD



8-11

FREIGHTER SLIDE POST AND COMPONENTS

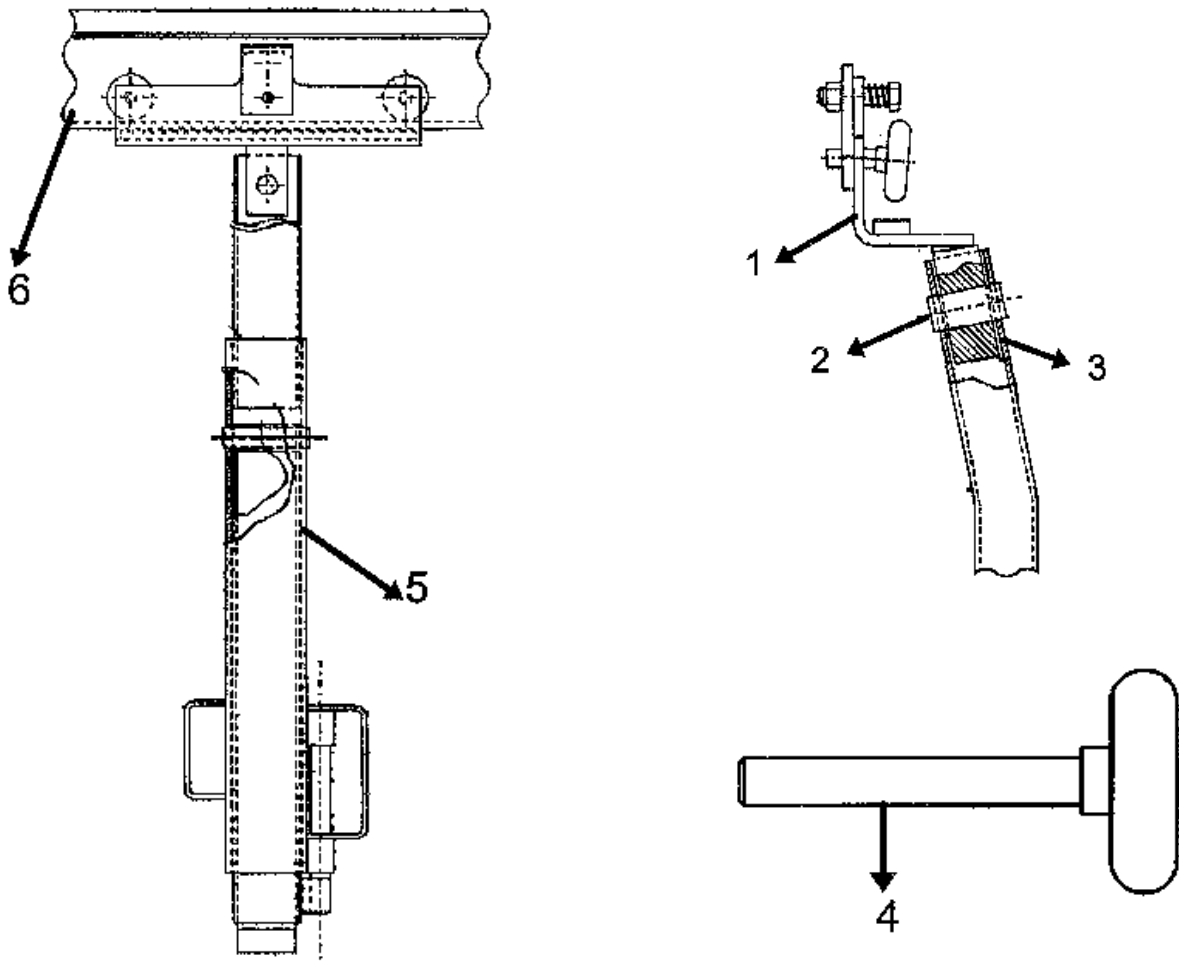

FRT-224-01011 - SLIDE POST ASSEMBLY – SUIT 2770mm HIGH APERTURE

ITEM	PART NUMBER	DESCRIPTION
1	FRT-224-00959	TOP ASSEMBLY ONLY – STANDARD
	FRT-224-01007	TOP ASSEMBLY ONLY C/W LOCK OUT KIT
2	FRT-224-00954	MOUNTING LUG
3	FRT-224-00958	MOUNTING PIN
4	FRT-WDK-2996FR	REPLACEMENT ROLLER ONLY
5	FRT-224-00950	SLIDE POST BOTTOM ONLY – STANDARD
	FRT-224-01044	SLIDE POST BOTTOM ONLY – REVERSIBLE
6	FRT-225-00262	SLIDE POST TRACK – 2.4 METRE LENGTH (GALVANISED)



8-12

REAR DOORS AND HARDWARE

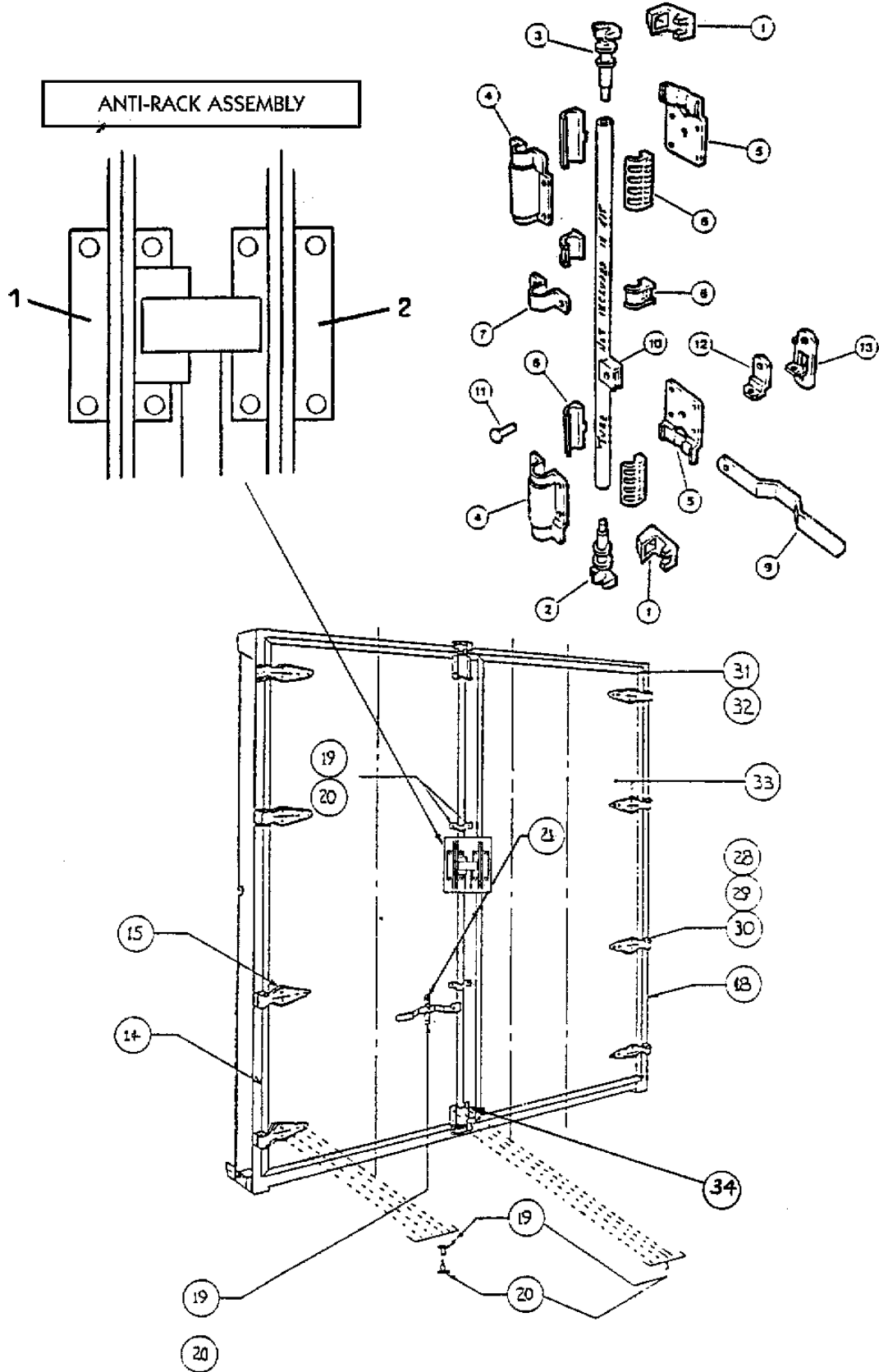



8-13

DOOR HARDWARE COMPONENTS

ITEM	PART NUMBER	DESCRIPTION
1	FRT-161-05062	CAM KEEPER - WELD ON
2	FRT-161-05064	CAM - RIGHT HAND
3	FRT-161-05063	CAM - LEFT HAND
4	FRT-161-05065	CAM GUIDE BRACKET - LONG
5	FRT-161-05066	CAM GUIDE BACKING PLATE - LONG
6	FRT-161-05067	CAM GUIDE BUSH - LONG (PAIR)
7	FRT-161-05068	ROD GUIDE BRACKET - SMALL
8	FRT-161-05069	ROD GUIDE BUSH - SMALL
9	FRT-161-05070	HANDLE
10	FRT-161-05071	HANDLE MOUNT BRACKET
11	FRT-161-05072	RIVET
12	FRT-161-05073	HANDLE RETAINER LATCH
13	FRT-161-05074	HANDLE RETAINER BRACKET
14	FRT-227-00689A	DOOR SEAL - 20mm x 3.3mt (HARD BACK)
	FRT-227-00689	DOOR SEAL - 20mm x 4.1mt (HARD BACK)
15	FRT-161-05061	HINGE BLADE C/W PIN & BUSHES
19	FRT-151-15790	CAMTAINER NUT
20	FRT-151-02440	CAMTAINER BOLT - RED
21	FRT-151-02439	CAMTAINER BOLT - WHITE
28	FRT-227-00698	HINGE BUTT - WELD ON
29	FRT-161-05075	HINGE BUSH - NYLON
30	FRT-227-00315	HINGE PIN ONLY
31	FRT-161-00039	CORNER TAB
33	FRT-227-00692	DOOR PANEL - 2775mm x 1170mm x 20mm
	FRT-227-00705	DOOR PANEL - 3200mm x 1170mm x 20mm
34	FRT-227-00707	WASHER - DOOR GEAR
	FRT-652-10035	DOOR HOLD BACK - TAUTLINER
	STL-PB-025	25NB STEEL BLACK PIPE

FRT-161-05060

POWERBRACE DOOR LOCKROD KIT

ANTI RACK COMPONENTS

1	FRT-227-00709	C-PLATE ASSEMBLY
2	FRT-227-00710	TONGUE ASSEMBLY
3	FRT-227-00708	ANTI RATTLE KIT COMPLETE



8-14

REAR DOOR AND HARDWARE MAXI CUBE

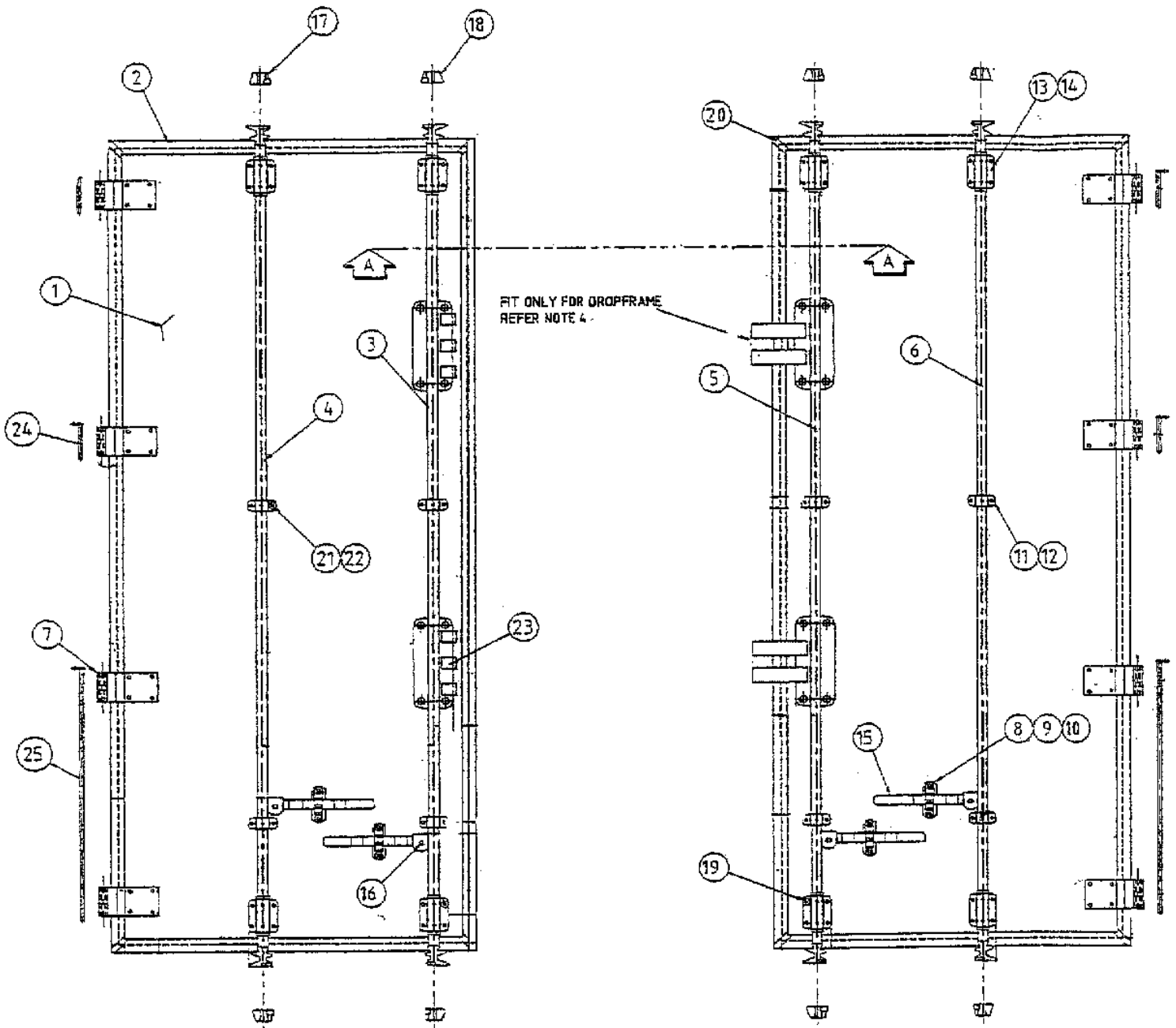



8-15

REAR DOOR COMPONENTS MAXI CUBE

ITEM	PART NUMBER	DESCRIPTION
1	FRT-227-00692	20mm DOOR BLANK - 2775mm x 1170mm
2	FRT-227-00689	20mm DOOR-SEAL - 4.1 METRE LENGTH
7	MAX-21266	HINGE BLADE - 50mm ALUMINIUM
8	MAX-46624	HANDLE RETAINER CATCH
9	MAX-35339	FLANGED SPACER WASHER
10	MAX-46625	HANDLE RETAINER PLATE
11	MAX-46626	BEARING BRACKET - SHORT
12	MAX-39781	NYLON BUSH - SHORT
13	MAX-47806	BEARING BRACKET - LONG
14	MAX-46629	NYLON BUSH - LONG
15	MAX-46630	HANDLE ASSEMBLY
16	MAX-46631	RIVET - 9.5 DIA x 28.5 LONG
17	MAX-30865	CAM KEEPER - LEFT HAND
18	MAX-30866	CAM KEEPER - RIGHT HAND
19	FRT-652-10035	DOOR HOLD BACK ASSEMBLY
20	FRT-161-00039	CORNER TAB - LONG
23	MAX-56239	ANTI RACK ASSEMBLY
24	MAX-48587	HINGE PIN ASSEMBLY - 130mm LONG
25	MAX-50336	HINGE PIN ASSEMBLY - 879mm LONG
26	MAX-	BLOXWICH CAM - LEFT HAND
27	MAX-	BLOXWICH CAM - RIGHT HAND
	MAX-57033	BLOXWICH DOOR HARDWARE KIT COMPLETE



8-16

FREIGHTER WHITING ROLLER DOOR

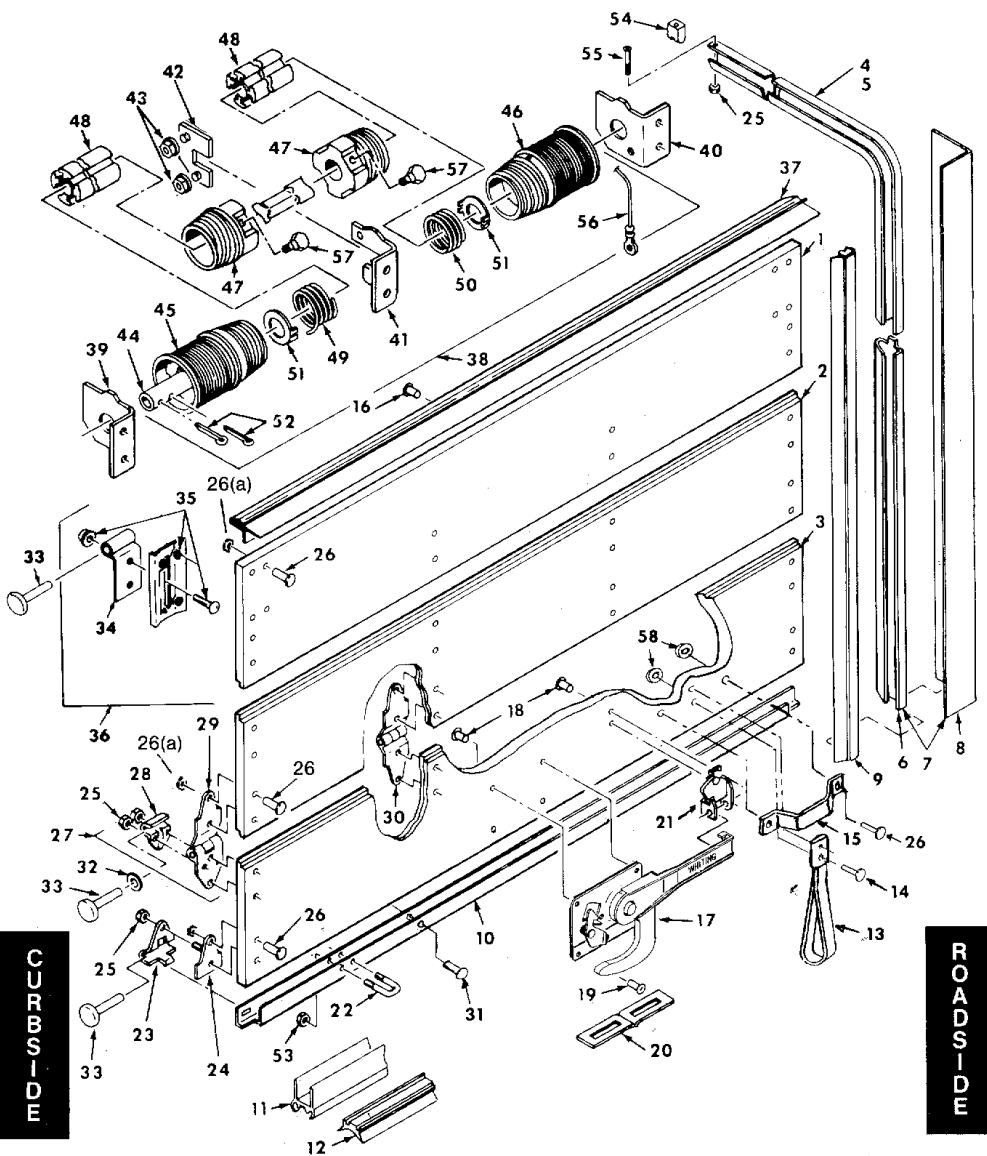

'Roll-up doors'
20MM DRY FREIGHT



8-17

WHITING DOOR COMPONENT LIST

ITEM	PART NUMBER	DESCRIPTION
2	FRT-WDK-342-11FR	11" INTERMEDIATE PANEL - 20mm
3	FRT-WDK-343-15R	15" BOTTOM PANEL - 20mm
4	FRT-WDK-11-2	2" HORIZONTAL TRACK - ROADSIDE
5	FRT-WDK-11-3	2" HORIZONTAL TRACK - CURBSIDE
6	FRT-WDK-1031	2" VERTICAL TRACK - ROADSIDE OR CURBSIDE
9	FRT-WDK-16-8FR	SIDE SEAL - PER LENGTH
10	FRT-WDK-18-3	BOTTOM 'U' CHANNEL - STEEL
11	FRT-WDK-1801	BOTTOM SEAL RETAINER - ALUMINIUM
12	FRT-WDK-1676	BOTTOM SEAL
13	FRT-WDK-23	PULL DOWN STRAP
15	FRT-WDK-1715	GRAB HANDLE
17	FRT-WDK-77	MAXIMUM SECURITY LOCK ASSEMBLY
20	FRT-WDK-2804	LATCH PLATE
21	FRT-WDK-2766	SECONDARY LOCK PLATE
22	FRT-WDK-70-13	CABLE ANCHOR 'U' BOLT
23	FRT-WDK-1021	BOTTOM ROLLER SHAFT COVER
24	FRT-WDK-1370	BOTTOM ROLLER STUD PLATE
26	HDW-BCO-0250-11	COACH BOLT - 11/4" x 1/4" UNC
26(a)	HDW-NYC-0250	NYLOC NUT - 1/4" UNC
28	FRT-WDK-1208	ROLLER HINGE COVER PLATE
29	FRT-WDK-1207	END HINGE ASSEMBLY
30	FRT-WDK-15FR	CENTRE HINGE ASSEMBLY
33	FRT-WDK-3228	2" NYLON ROLLER
34	FRT-WDK-6943FR	TOP ROLLER HOLDER
35	FRT-WDK-1264	TOP CLOSURE BASE ASSEMBLY
37	FRT-WDK-4032	TOP SEAL - PER LENGTH
38	FRT-WDK-2376	COUNTER BALANCE SHAFT ASSEMBLY (LESS 39-43,52)
39	FRT-WDK-2524	BALANCER BRACKET - CURBSIDE
40	FRT-WDK-2523	BALANCER BRACKET - ROADSIDE
41	FRT-WDK-2525	BALANCER BRACKET - CENTRE
42	FRT-WDK-2526	BALANCER BRACKET CLAMP
54	FRT-WDK-83FR	2" TRACK STOP BUMPER
56	FRT-WDK-1-4	STAINLESS STEEL DOOR CABLE WITH EYE

ROLL UP DOOR ASSEMBLY

EQP-DH-10	20MM DRY FREIGHT DOOR - HEIGHT 1900mm - 2200mm
EQP-DH-11	20mm DRY FREIGHT DOOR - HEIGHT 2200mm - 2500mm
EQP-DH-12	20mm DRY FREIGHT DOOR - HEIGHT 2500mm - 2800mm

20mm F.R.P PANEL OR COLD SAVER DOORS ALSO AVAILABLE



8-18

WONDERSLIDE CURTAIN LUBRICANT

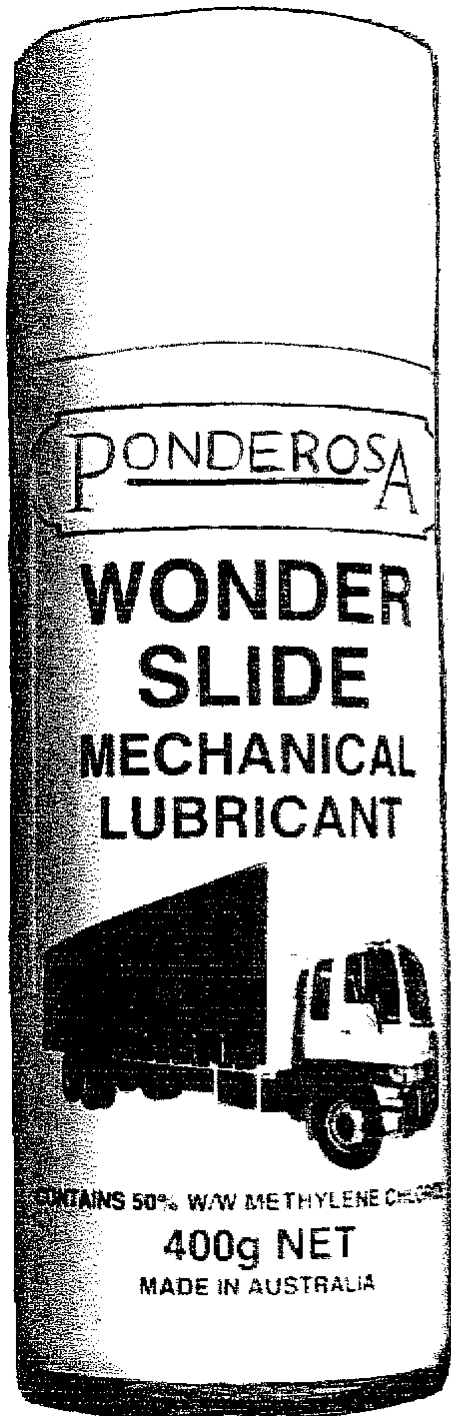

PART NUMBER

SXT-25-2924

DESCRIPTION

WONDERSLIDE - CURTAIN ROLLER
LUBRICANT



AVAILABLE IN A 400g NET
AEROSOL SPRAY CAN

(CARTON PACK OF 12 CANS AVAILABLE)



8-19

CURTAIN BODY COMPONENTS

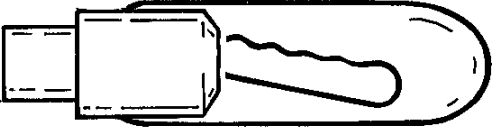
PRODUCTS	PART NUMBER	DESCRIPTION
	<p>FRT-237-00460</p>	<p>CURTAIN TRACK END CASTING – WITH BOW FRONT</p>
	<p>FRT-237-00462</p>	<p>CURTAIN TRACK END CASTING – NIL BOW FRONT</p>
	<p>FRT-237-00461</p>	<p>PELMET RUBBER RETAINER</p>
	<p>HDW-AF-3285ZP</p>	<p>BABY BOLT ON ANTI LUCE FASTENER</p>
	<p>HDW-AF-3275-002</p>	<p>LARGE BOLT ON ANTI LUCE FASTENER</p>
	<p>HDW-AF-3274-001</p>	<p>BABY WELD ON ANTI LUCE FASTENER</p>
	<p>HDW-AF-3232-001</p>	<p>LARGE WELD ON ANTI LUCE FASTENER</p>



8-20

BODY COMPONENTS

PRODUCT	PART NUMBER	DESCRIPTION
	<p>MAX-23318</p>	<p>TIE RAIL POST – 86mm LONG</p>
	<p>FRT-201-01523</p>	<p>TIE RAIL POST – 102mm LONG</p>
	<p>SXT-25-2560</p>	<p>GATE POCKET – 4” COAMING</p>
	<p>FRT-201-01821</p>	<p>GATE POCKET – 5” COAMING</p>
	<p>FRT-224-00968</p>	<p>CLIP ON GATE POCKET – SUIT SLIDING POST</p>
	<p>FRT-222-00347</p>	<p>LOADRACK POCKET – CENTRE (PIPE)</p>



 A photograph of a cast metal part, a loadrack pocket end, showing its rectangular shape and a circular hole on one side.	FRT-237-00239	LOADRACK POCKET – END (CAST)
--	----------------------	---------------------------------

8-21

LIGHT BRACKETS



PRODUCT	PART NUMBER	DESCRIPTION
 A black silhouette of a single LED light bracket, showing a rectangular top section and a circular opening with a central hole.	MAX-48663	L.E.D LIGHT BRACKET – SINGLE
 A black silhouette of a double LED light bracket, showing a rectangular top section and two circular openings, each with a central hole.	MAX-53292	L.E.D LIGHT BRACKET - DOUBLE
 A photograph of a metal light bracket for a freighter, showing its rectangular shape and a central slot.	FRT-229-00226	LIGHT BRACKET - FREIGHTER



	<p>FHF-X0416-B</p>	<p>LIGHT BRACKET – MAXI CUBE (ALUMINIUM)</p>
---	---------------------------	--

8-22

MAXI CUBE EXTRUSIONS

PRODUCT	PART NUMBER	DESCRIPTION
	<p>FHF-D-53002</p>	<p>TOP FRONT RAIL ALUMINIUM EXTRUSION 2.2 mt LONG – SUIT MAXI CUBE DRY FREIGHT VAN</p>
	<p>FHF-D-53000</p>	<p>TOP RAIL ALUMINIUM EXTRUSION – SUIT MAXI CUBE DRY FREIGHT VAN</p>
	<p>FHF-D-54000</p>	<p>BOTTOM RAIL ALUMINIUM EXTRUSION – SUIT MAXI CUBE DRY FREIGHT VAN</p>



	<p>FHF-D550002</p>	<p>ALUMINIUM CORNER POST 2.9mts LONG – SUIT MAXI CUBE DRY FREIGHT VAN</p>
	<p>FHF-E0006A</p>	<p>ALUMINIUM TOP CORNER CASTING – SUIT MAXI CUBE DRY FREIGHT VAN</p>

8-23

DOOR COMPONENTS

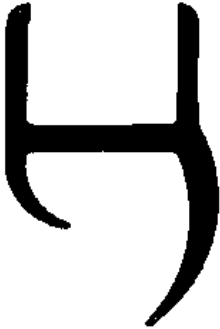
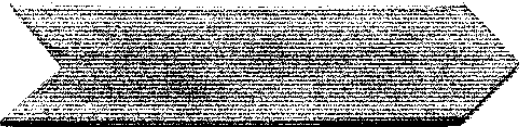
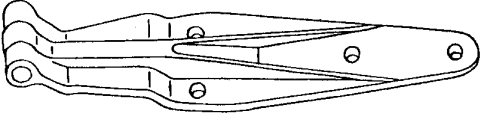
PRODUCT	PART NUMBER	DESCRIPTION
	<p>FRT-227-00644</p>	<p>DOOR SEAL – SUIT 16mm PANEL HARD BACK (GREY) 4.1 METRE LENGTH</p>
	<p>FRT-227-00689</p>	<p>DOOR SEAL – SUIT 20mm PANEL HARD BACK (GREY) 4.1 METRE LENGTH</p>
	<p>FRT-161-00039</p>	<p>CORNER TAB – GREY 80mm LONG</p>
	<p>FRT-161-05061</p>	<p>HINGE BLADE C/W BUSHES</p>



	FRT-227-00315	HINGE PIN ONLY
	FRT-161-05075	REPLACEMENT BUSH ONLY
	FRT-223-00214	HINGE BUTT – BOLT ON (OFFSET)
	FRT-227-00698	HINGE BUTT – WELD ON

8-24

MAXI CUBE HINGE

PRODUCT	PART NUMBER	DESCRIPTION
	MAX-21266	ALUMINIUM HINGE BLADE – 50mm OFFSET SUIT CURTAIN SIDER AND DRY FREIGHT VANS
	MAX-30159	ALUMINIUM HINGE BLADE – 65mm OFFSET SUIT REFRIGERATED VANS AND CURTAIN SIDERS



	<p>MAX-31680</p>	<p>HINGE BUTT – NEW STYLE FOR ALLOY HINGE</p>
	<p>MAX-48587</p>	<p>HINGE PIN – ALLOY HINGE</p>
	<p>MAX-50336</p>	<p>DUAL HINGE PIN / GRAB HANDLE – ALLOY HINGE</p>

8-25

DOOR SEAL MAXI CUBE

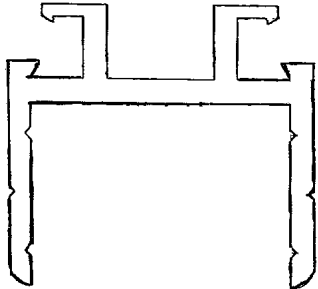
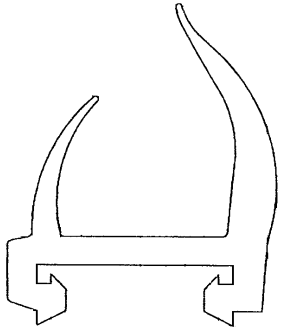
PRODUCT	PART NUMBER	DESCRIPTION
	<p>FHF-D-92001</p>	<p>ALUMINIUM TRACK – SUIT DOOR SEAL ON MAXI CUBE VAN</p>
	<p>FHF-H-00240</p>	<p>DOOR SEAL – MAXI CUBE</p>

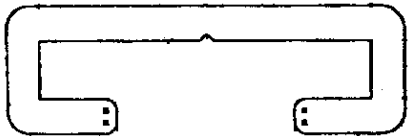
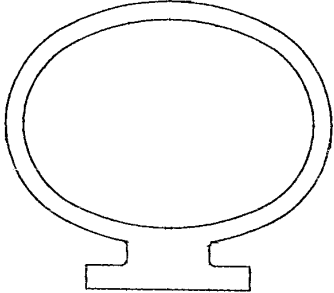

	<p align="center">FHF-D-89001</p>	<p>ALUMINIUM DOOR SEAL RETAINER – MAXI CUBE</p>
	<p align="center">FHF-H-00158</p>	<p>DOOR SEAL – MAXI CUBE</p>

8-26

BODY FASTENERS

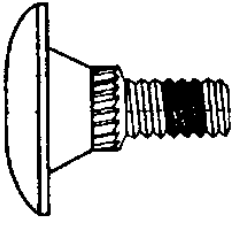
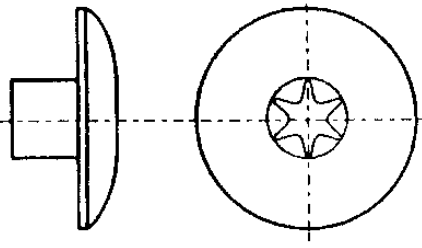
PRODUCT	PART NUMBER	DESCRIPTION
	<p align="center">FRT-151-02436</p>	<p>CAMTAINER BOLT – BLACK GRIP RANGE 22mm – 26mm</p>
	<p align="center">FRT-151-02440</p>	<p>CAMTAINER BOLT – RED GRIP RANGE 25mm – 30mm</p>
	<p align="center">FRT-151-15790</p>	<p>CAMTAINER NUT – STANDARD</p>
	<p align="center">FRT-151-15812</p>	<p>CAMTAINER NUT - LONG</p>
	<p align="center">FHF-Z50156</p>	<p>SCREW – 5/16" x 1" LONG PHILLIPS HEAD</p>



	FHF-Z50156	SCREW – 5/16” x 1” LONG PHILLIPS HEAD
	FHF-Z50157	SCREW – 5/16” x 1 ¼” LONG PHILLIPS HEAD
	FHF-Z30720	TEE NUT – 5/16”
	FHF-Z45001	NYLON WASHER – 5/16”

8-27

DOOR HOLD BACK

PRODUCT	PART NUMBER	DESCRIPTION
	SXT-25-2526	DOOR HOLD BACK SET – VAN



 A black door hold back set consisting of a long, flexible strap with a metal bracket and a small green component.	FRT-652-10035	DOOR HOLD BACK SET – CURTAIN SIDER
 A grey, rectangular bumper end casting with a triangular cutout and a small protrusion on the right side.	FRT-237-00475	BUMPER END CASTING – EARLY FREIGHTER
 A grey, rectangular bumper end casting with a series of horizontal ridges or grooves across its surface.	MAX-38779	BUMPER END CASTING – MAXITRANS
 A grey, square-shaped step end casting with a slightly raised, stepped top surface.	FRT-237-00476	STEP END CASTING